

Cable Ducts

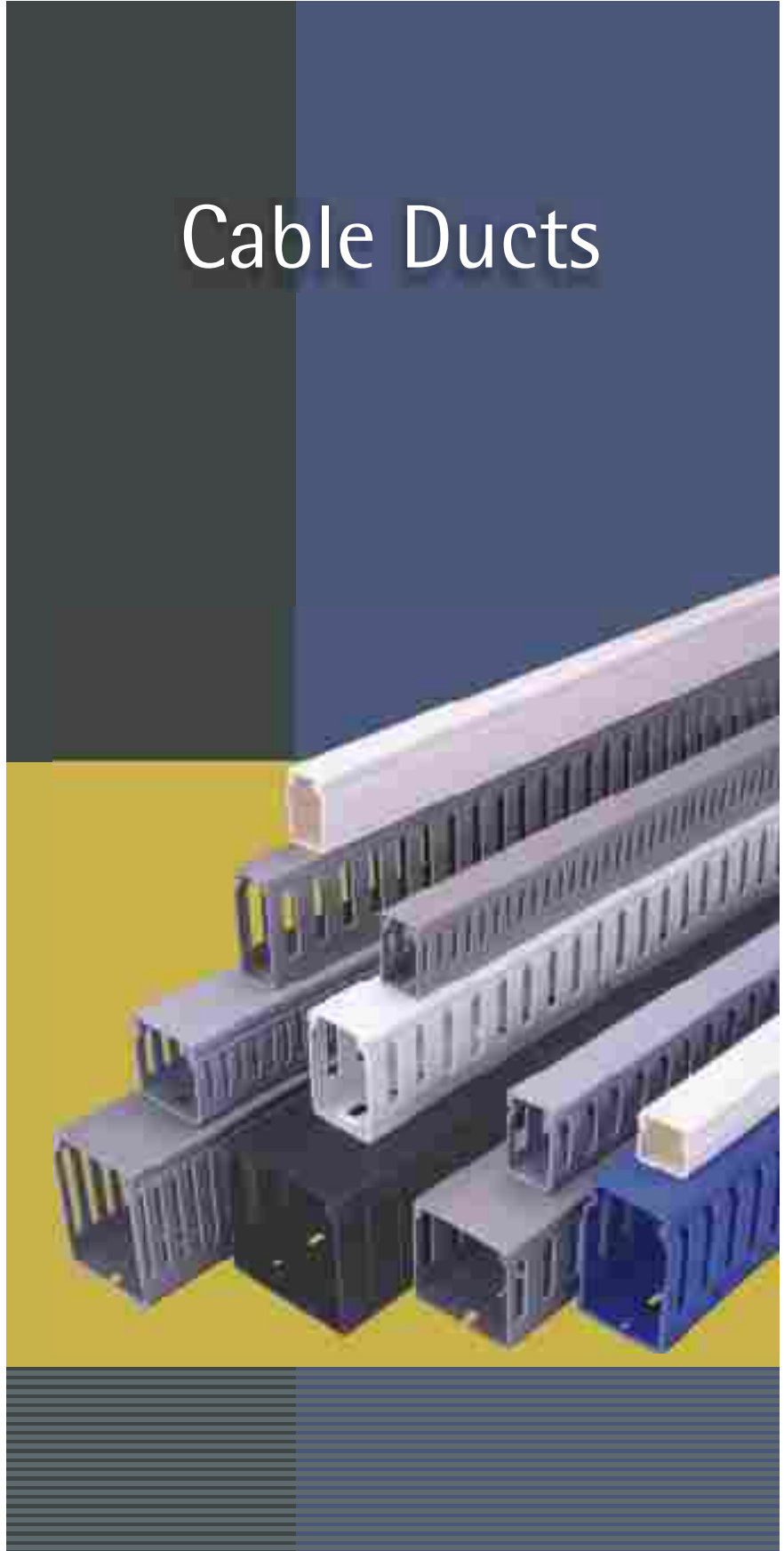

FEATURES

Manufactured from specially compounded high-impact rigid polyvinyl chloride.

Will not peel, chip or crack.

Resists oils, salt solutions and fungus.

Nonflammable, warp-proof and non-brittle.

High dielectric strength and withstands temperatures upto 70°C.

Tested as per European and North American Standards. Carries CSA, UL and CE mark.



Unique cover locking design prevents popping up of wires while removing cover.

Elongated slots at the bottom allows flexible mounting.

Heavy, robust sections.

APPLICATIONS

Facilitates systematic Wiring.

Enhances aesthetic and clarity.

Permits faster connections, addition and fault tracing of wires.

Avoids bunching, and tapping.

Provides complete electrical insulation.

MATERIAL SPECIFICATION.

Material:
High impact, self extinguishing, warp-proof rigid PVC.

Other materials such as chlorine free PPO is available on request.

COLOUR:

Standard: Greenish grey for B type and light grey for A type.

Other colours: Black, Ivory, White, Blue and Green are available for large quantities.

MECHANICAL PROPERTIES

Tensile strength - 390 kg/cm² IZOD
impact strength - 7kg.cm/cm

ELECTRICAL PROPERTIES:

Dielectric strength - 36 kV/mm
Specific resistance
- 6.1 x 10¹⁴ ohm-cm

FLAMMABILITY:

UL 94 VO.

Slotting Styles (A & B Types)

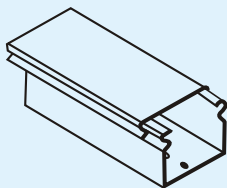

UNSLOTTED
(US)

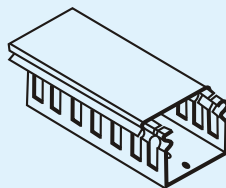

STANDARD SLOTTED
(S)

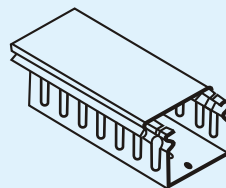

STRAIGHT SLOTTED
(L)

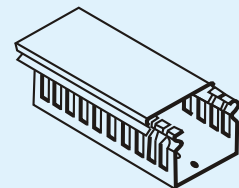

THIN SLOTTED
(T)

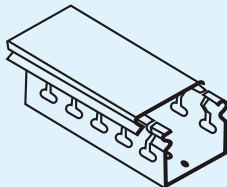

HORIZONTAL SLOTTED
(H)

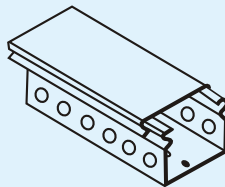

CIRCULAR SLOTTED
(C)

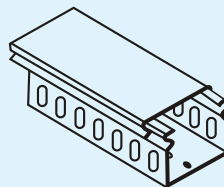

OBLONG SLOTTED
(O)

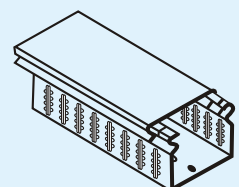

MULTIPLE SLOTTED
(M)

B TYPE

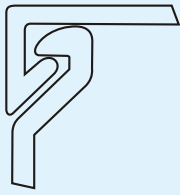

Non slip cover design of minimum encumbrance and maximum grip

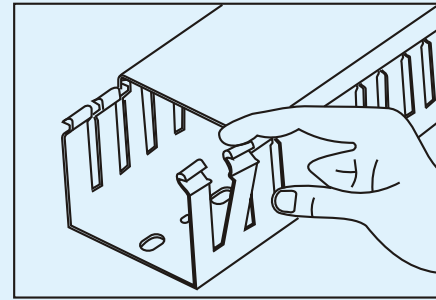
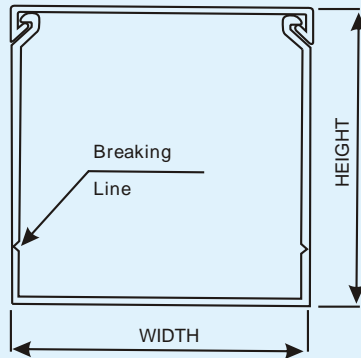

Snap-off side wall fingers permit enlarging slot for any size of wire or wire bundles. Requires no tools for cutting.

Channel with cover width x Height (mm)	CABLEHOUSING CAPACITY (Numbers)			Standard Pack Channel with cover (IN1 MTRS)	Standard Pack Channel with cover (IN 2 MTRS)	Available Slotting Style
	1.5 mm ² OD 3.18mm (16 AWG)	2.5 mm ² OD 3.53 mm (14 AWG)	4mm ² OD 4.01 mm (12 AWG)			
B25 x 30	37	30	23	100	40	S
B25 x 40	48	39	31	75	40	S,T
B25 x 60	72	57	45	50	35	S.T
B25 x 80	92	75	59	50	25	S.T
B25 x 100	126	105	81	50	25	S
* B30 x 20	31	25	20	100	40	US
** B33 x 100	161	131	103	50	24	S
B37.5 x 75	135	110	86	50	25	S
* B45 x 20	40	32	25	75	30	US
B40 x 40	81	65	51	50	30	S,T
B40 x 60	121	98	77	50	30	S,T
B40 x 80	160	130	102	50	25	S,T,O
B40 x 100	200	164	128	40	20	S.T
** B48 x 100	135	195	152	40	18	S.T
B50 x 75	187	152	119	50	24	S
** B55 x 100	281	228	179	30	18	S,T
* B60 x 20	61	50	39	50	25	US
B60 x 40	123	99	78	50	25	S,T
B60 x 60	180	146	114	50	25	S,T
B60 x 80	246	199	156	40	20	S,T,O
B60 x 100	308	247	194	30	18	S.T
B72 x 64	234	190	149	32	16	S
B75 x 75	291	236	185	32	16	S
B75 x 100	394	333	251	24	12	S.T
B80 x 40	165	134	105	50	25	S.T
B80 x 60	251	203	159	40	20	S.T
B80 x 80	337	272	214	32	16	S,T,O
B80 x 100	416	332	248	25	14	S.T
B100 x 60	316	256	201	30	18	S.T
B100 x 80	425	344	270	24	14	S,T
** B100 x 100	531	429	336	18	10	S.T
B125 x 75	499	405	318	18	8	S
B150 x 100	807	653	512	12	8	S,T
B150 x 150	1100	960	750	8	4	S,T

AVAILABLE IN UNSLOTTED ONLY.

** AVAILABLE FROM APRIL 2004



COVER STANDARD PACK

COVER CODE	COVER STANDARD PACK TOTAL LENGTH IN METRES
BC25	100
BC30	100
BC33	100
BC40	64
BC37.5	52
BC50	64
BC75	44
BC60	44
BC72	44
BC80	44
BC100	44
BC125	25
BC150	25

SLOTING STYLE

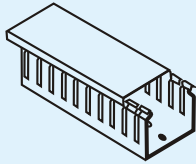

STANDARD SLOT
(S)

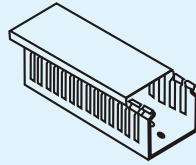

THIN SLOT
(T)

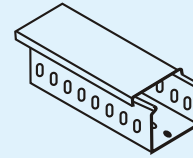

OBLONG SLOT
(O)

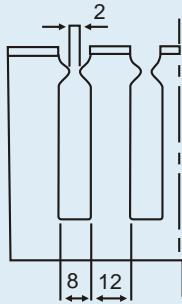

STANDARD SLOT

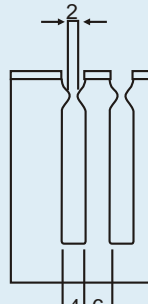

THIN SLOT

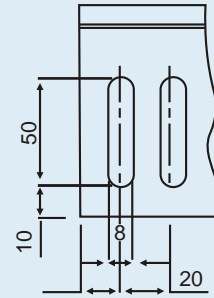

OBLONG SLOT

BOTTOM SLOTING STYLE

DUCT WIDTH : 25mm, 30 mm, 33mm and 37.5 mm



DUCT WIDTH : 150mm



DUCT WIDTH : 40mm,45 mm,48 mm, 50mm, 55mm, 60mm, 72mm, AND 75mm

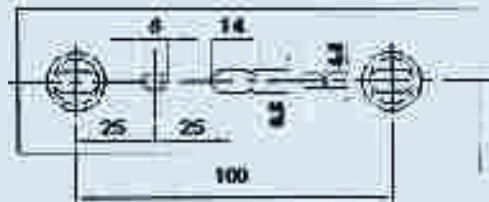

DUCT WIDTH : 80mm,100mm and 125 mm



All dimensions in mm

A TYPE

Specially designed profiles of duct and cover for fast and efficient locking.

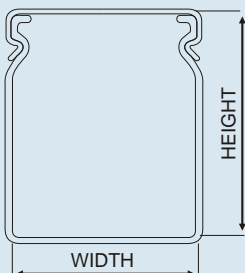

CHANNEL WITH COVER HEIGHT X WIDTH(mm)	CABLE HOUSING CAPACITY (Nos)			AVAILABLE SLOTTING STYLES	STANDARD PACK CHANNEL WITH COVER	
	1.5 mm ² OD 3.53 mm (16 AWG)	2.5 mm ² OD 3.53 mm (14 AWG)	4 mm ² OD 4.01 mm (12 AWG)		1 MTR	2 MTR
A15x15	11	9	7	H	50	100
A15X25	19	15	12	H	50	64
A25X25	31	25	20	S,O,T	50	48
A30X25	37	30	23	S,O,T	50	48
A40X30	59	48	37	S,T	30	48
A45X25	56	45	35	S, O, C, M, T, L	30	48
A45X30	67	54	42	S, O, C, M, T, L	25	32
A45X45	100	81	63	S, O, C, M, T, L	30	18
A45X60	134	108	84	S, O, C, M, T, L	25	24
A60X25	74	60	47	S, O, T	30	18
A60X45	134	108	84	S, O, T	30	18
A60X60	178	145	112	S,O,T	25	18
A60X120	356	289	224	S	8	4
A75X45	167	135	105	S,T,C	24	18
A75X75	278	226	175	S,T,C	16	8
A80X80	316	257	199	S,T	16	8
A100X100	495	401	311	S	6	4

Note: All sizes are available in unslotted (us) style.

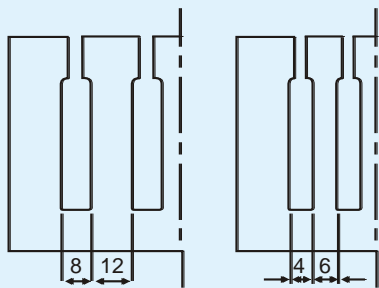

STANDARD SLOT



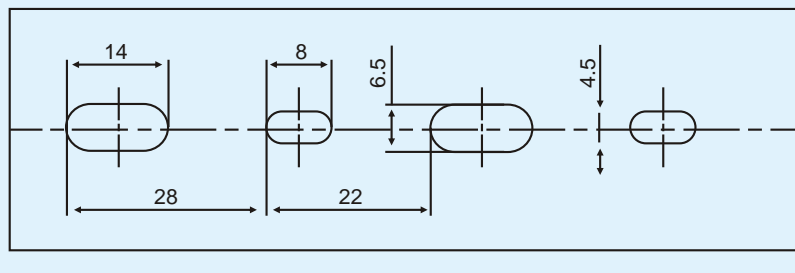



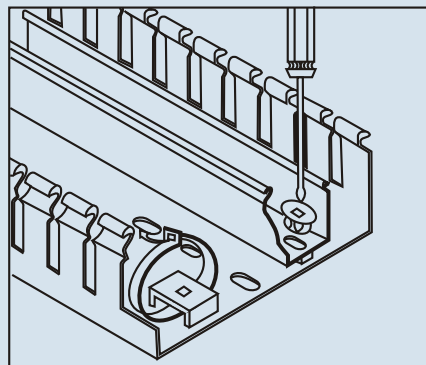
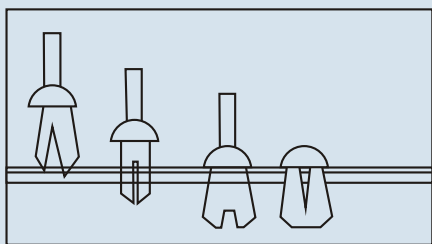

THIN SLOT



BOTTOM MOUNTING SLOTS FOR ALL SIZES

ACCESSORIES



SR. NO.	PART NAME	FIGURE	ORDERING CODE	STANDARD PACKING
1	FIXING LUG		BFL 1	100
2	CABLE TIE ATTACHMENT		BCT 1	100
3	NYLON FASTENER		BNF 1 (6 mm)	100
			BNF 2 (4 mm)	100
4	WIRE RETAINER I		BWR 1	100
5	WIRE RETAINER II		BWR 2 *	100
6	NAME PLATE		BNP 1 *	100
7	MOUNTING CLIP I		BMC 1	100
8	MOUNTINGCLIP II		BMC 2	100

*- Pls. specify size & slotting style while Ordering.

ORDERING PROCEDURE

TYPE	SIZE	SLOTTING	TOTAL LENGTH (in multiple of standard packs)
A	45 x 45	T	36 metres
B	60 x 60	S	48 metres

All dimensions are in mm

Product improvement is a continuous process. Hence data given in this catalogue is subject to change without intimation.

REGISTERED OFFICE AND HEAD OFFICE

L&T House, Ballard Estate
P. O. Box 278,
Mumbai 400 001
Tel: 022-22618181/ 2, 22685656
Fax: 022-22685858
Website: www.larsentoubro.com

ELECTRICAL STANDARD PRODUCTS (ESP)

501, Sakar Complex,
Opp. Gandhigram Rly. Stn.
Ashram Road,
Ahmedabad 380009
Tel: 079-26581790 / 5
Fax: 079-26580491
e-mail: esp-ahm@Intebg.com

38, Cubbon Road, P. O. Box 5098
Bangalore 560 001
Tel: 080-25020324 / 325
Fax: 080-25580525
e-mail: esp-blr@Intebg.com

131/1, Zone II,
Maharana Pratap Nagar,
Bhopal 462 011.
Tel: 0755-2576977/ 5273517
Fax: 0755-2553264
e-mail: esp-bho@Intebg.com

Plot No. 559 Annapurna Complex,
Lewis Road,
Bhubaneswar 751 014.
Tel: 0674-2537301, 2436696
Fax: 0674-2537309
e-mail: esp-bbi@Intebg.com

SCO 32, Sector 26-D
Madhya Marg, P. O. Box 14
Chandigarh 160 026.
Tel: 0172-2791257, 5087487
Fax: 0172-2792764
e-mail: esp-chd@Intebg.com

10, Club House Road
Chennai 600 002.
Tel: 044-28462072 / 4
Fax: 044-28462102
e-mail: esp-maa@Intebg.com

67, Appuswamy Road
Post Bag 7156,
Opp. Nirmala College
Coimbatore 641 045
Tel: 0422-2314112
Fax: 0422-2313881
e-mail: esp-cbe@Intebg.com

L&T House
Group MIG - 5
Padmanabhpur
Durg 491 001
Tel: 0788-2200105
Fax: 0788-2210161

A1/11, Astronauts Avenue
Bidhan Nagar
Durgaur 713 212
Tel: 0343-2537844
Fax: 0343-2536493
e-mail: esp-dgp@Intebg.com

(Faridabad Switchgear Works)
12/4, Delhi-Mathura Road
Faridabad 121 003.
Tel: 0129-2277543, 2275314
Fax: 0129-2275405
e-mail: esp-fbd@Intebg.com

Milanpur Road, Bamuni Maidan
Guwahati 781 021.
Tel: 0361-2550565
Fax: 0361-2551308
e-mail: esp-gau@Intebg.com

5-10-173, Fateh Maidan Road
P. O. Box 12,
Hyderabad 500 004.
Tel: 040-23296468
Fax: 040-23242356
e-mail: esp-hyd@Intebg.com

D-24, Prithvi Raj Road
C-Scheme,
Jaipur 302 001.
Tel: 0141-2377374, 2360252
Fax: 0141-2373280
e-mail: esp-jai@Intebg.com

Akashdeep Plaza, 2nd Floor
P. O. Golmuri
Jamshedpur 831 003.
Tel: 0657-2433673
Fax: 0657-22341250
e-mail: esp-jam@Intebg.com

Skybright Bldg., M.G. Road
Ravipuram Junction
Ernakulam
Kochi 682 016.
Tel: 0484-2358513, 2358761
Fax: 0484-2358982
e-mail: esp-cok@Intebg.com

3-B, Shakespeare Sarani
Kolkata 700 071.
Tel: 033-22822589
Fax: 033-22821025
e-mail: esp-ccu@Intebg.com

A28, Indira Nagar
Faizabad Road
Lucknow 226 001.
Uttar Pradesh
Tel: 0522-3098956
Fax: 0522-2311671
e-mail: esp-lko@Intebg.com

Plot No. 518,
4th Main Road,
K.K. Nagar
Madurai 625 020.
Tel: 0452-2537404/303
Fax: 0452-2537552
e-mail: esp-mdu@Intebg.com

ABEB-1, Powai,
Mumbai 400 072.
Tel: 022-55052287/2661/2737
Fax: 022-55051112
e-mail: esp-bom@Intebg.com

8-B, Farmland, Ramdas Peth
Behind Hotel Radhika
Nagpur 440 010.
Tel: 0712-2556335
Fax: 0712-2564365
e-mail: esp-nag@Intebg.com

32, Shivaji Marg, P.O. Box 6223
New Delhi 110 015.
Tel: 011-51419500 / 1, 51419515
Fax: 011-51419600
e-mail: esp-del@Intebg.com

L&T House, P.O. Box 119
191/1, Dhole Patil Road
Pune 411 001.
Tel: 020-26135048, 26135611
Fax: 020-6129586, 26124910
e-mail: esp-pnq@Intebg.com

3rd Floor, Vishwakarma Chamber
Majura Gate, Ring Road
Surat 395 002.
Tel: 0261-2473726
Fax: 0261-2477078
e-mail: esp-sur@Intebg.com

48-8-16, Dwarakanagar
Visakhapatnam 530 016.
Tel: 0891-2755493, 2704928
Fax: 0891-2746075
e-mail: esp-viz@Intebg.com

Radhadaya Complex
Old Padra Road
Near Charotar Society
Vadodara 390 015.
Tel: 0265-2334799, 2311744
Fax: 0265-2336184
e-mail: esp-bar@Intebg.com

For the latest information and special applications, please contact any of our offices listed here.

Marketed by:



LARSEN & TOUBRO LIMITED
Electrical Standard Products

Manufactured by:

salzer

Salzer Group of Companies
Coimbatore. Website : www.salzergroup.com